

# Data Sheet



Article number: 0108062

Description: Retaining ring JK 45 DIN 984

## Measures

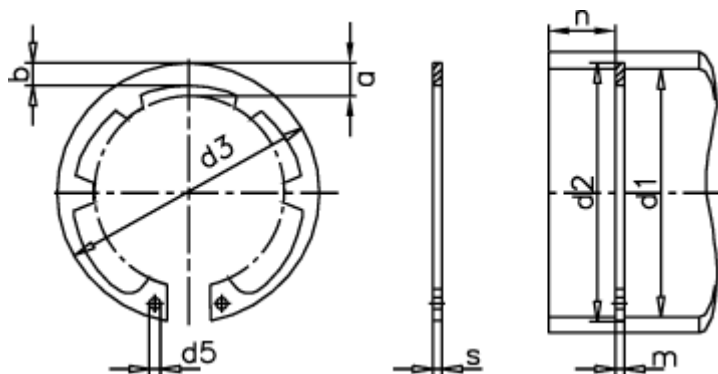

a max	= 7.2	FN kN	= 30.2	s	= 1.75
AN mm <sup>2</sup>	= 181.0	FRg kN	= 8.2	t	= 1.25
b	= 4.3	FR kN	= 43.1	tol	= +0,25
d1	= 45	g	= 2.0	tol	= -0.06
d2	= 47.5	K kN-mm	= 78.1	tol	= +0,90-0,39
d3	= 48.5	m min	= 1.85	Tong	= ZGJ-3
d5 min	= 2.5	Nominal drive	= 3.8	Weight kg/1000	= 6.60
Description	= JK 45	Number of serrations	= 6		